

SINGLE 2-INPUT OR GATE

- HIGH SPEED: $t_{PD} = 4.5\text{ns}$ (TYP.) at $V_{CC} = 5\text{V}$
- LOW POWER DISSIPATION:
 $I_{CC} = 1\mu\text{A}$ (MAX.) at $T_A=25^\circ\text{C}$
- COMPATIBLE WITH TTL OUTPUTS:
 $V_{IH} = 2\text{V}$ (MIN), $V_{IL} = 0.8\text{V}$ (MAX)
- POWER DOWN PROTECTION ON INPUTS
- SYMMETRICAL OUTPUT IMPEDANCE:
 $|I_{OH}| = I_{OL} = 8\text{mA}$ (MIN) at $V_{CC} = 4.5\text{V}$
- BALANCED PROPAGATION DELAYS:
 $t_{PLH} \cong t_{PHL}$
- OPERATING VOLTAGE RANGE:
 $V_{CC}(\text{OPR}) = 4.5\text{V}$ to 5.5V
- IMPROVED LATCH-UP IMMUNITY

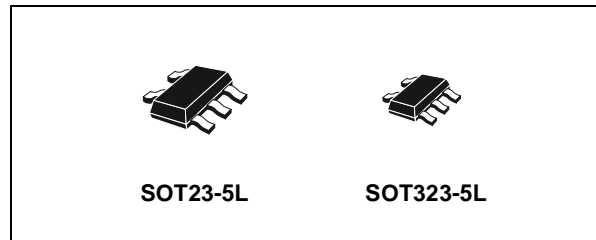

ORDER CODES

| PACKAGE | T & R |
|-----------|------------|
| SOT23-5L | 74V1T32STR |
| SOT323-5L | 74V1T32CTR |

DESCRIPTION

The 74V1T32 is an advanced high-speed CMOS SINGLE 2-INPUT OR GATE fabricated with sub-micron silicon gate and double-layer metal wiring C²MOS technology. The internal circuit is composed of 2 stages including buffer output, which provide high noise immunity and stable output.

Power down protection is provided on all inputs and 0 to 7V can be accepted on inputs with no regard to the supply voltage. This device can be used to interface 5V to 3V.

PIN CONNECTION AND IEC LOGIC SYMBOLS

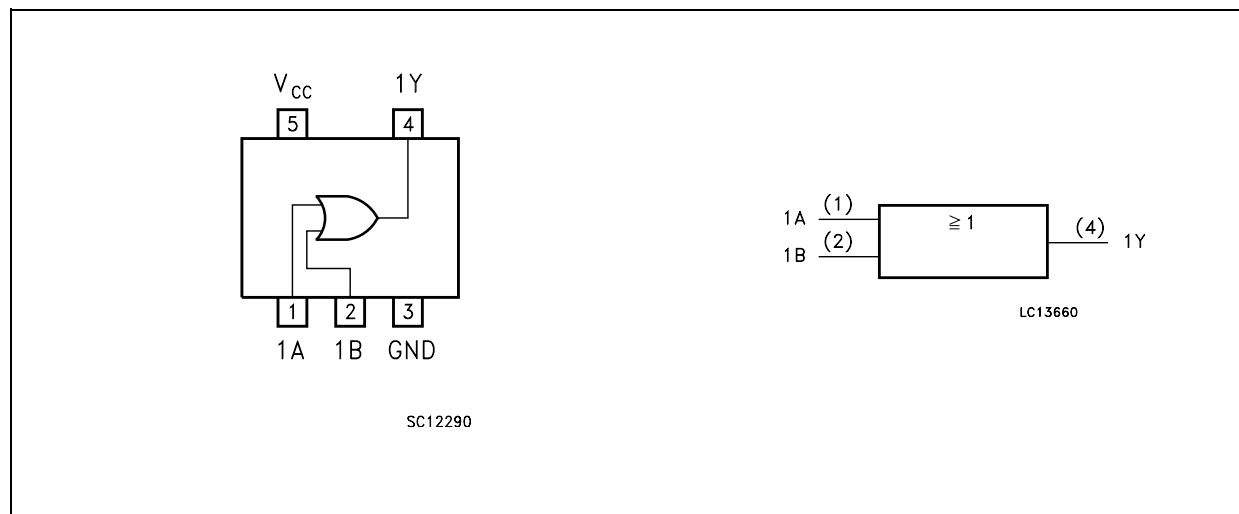

INPUT EQUIVALENT CIRCUIT

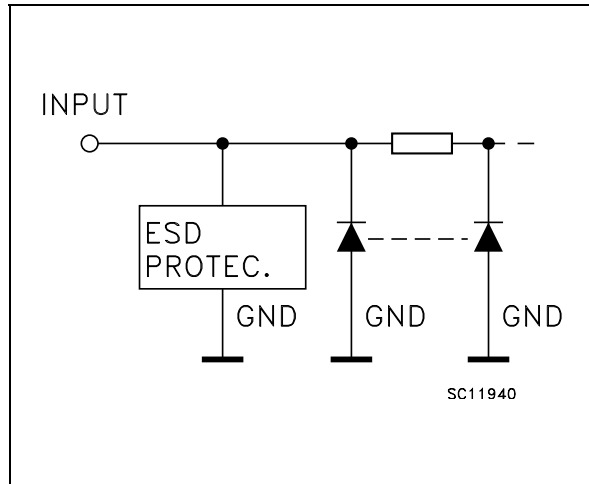

PIN DESCRIPTION

| PIN N° | SYMBOL | NAME AND FUNCTION |
|--------|-----------------|-------------------------|
| 1 | 1A | Data Input |
| 2 | 1B | Data Input |
| 4 | 1Y | Data Output |
| 3 | GND | Ground (0V) |
| 5 | V _{CC} | Positive Supply Voltage |

TRUTH TABLE

| A | B | Y |
|---|---|---|
| L | L | L |
| L | H | H |
| H | L | H |
| H | H | H |

ABSOLUTE MAXIMUM RATINGS

| Symbol | Parameter | Value | Unit |
|-------------------------------------|--------------------------------------|-------------------------------|------|
| V _{CC} | Supply Voltage | -0.5 to +7.0 | V |
| V _I | DC Input Voltage | -0.5 to +7.0 | V |
| V _O | DC Output Voltage | -0.5 to V _{CC} + 0.5 | V |
| I _{IK} | DC Input Diode Current | - 20 | mA |
| I _{OK} | DC Output Diode Current | ± 20 | mA |
| I _O | DC Output Current | ± 25 | mA |
| I _{CC} or I _{GND} | DC V _{CC} or Ground Current | ± 50 | mA |
| T _{stg} | Storage Temperature | -65 to +150 | °C |
| T _L | Lead Temperature (10 sec) | 300 | °C |

Absolute Maximum Ratings are those values beyond which damage to the device may occur. Functional operation under these conditions is not implied.

RECOMMENDED OPERATING CONDITIONS

| Symbol | Parameter | Value | Unit |
|-----------------|--|----------------------|------|
| V _{CC} | Supply Voltage | 4.5 to 5.5 | V |
| V _I | Input Voltage | 0 to 5.5 | V |
| V _O | Output Voltage | 0 to V _{CC} | V |
| T _{op} | Operating Temperature | -55 to 125 | °C |
| dt/dv | Input Rise and Fall Time (note 1) (V _{CC} = 5.0 ± 0.5V) | 0 to 20 | ns/V |

1) V_{IN} from 0.8V to 2V

DC SPECIFICATIONS

| Symbol | Parameter | Test Condition | | Value | | | | | | Unit | |
|------------------|--------------------------------------|------------------------|--|-----------------------|------|-------|-------------|-------|--------------|-------|------|
| | | V _{CC} (V) | | T _A = 25°C | | | -40 to 85°C | | -55 to 125°C | | |
| | | | | Min. | Typ. | Max. | Min. | Max. | Min. | | Max. |
| V _{IH} | High Level Input Voltage | 4.5 to 5.5 | | 2 | | | 2 | | 2 | | V |
| V _{IL} | Low Level Input Voltage | 4.5 to 5.5 | | | | 0.8 | | 0.8 | | 0.8 | V |
| V _{OH} | High Level Output Voltage | 4.5 | I _O =-50 μA | 4.4 | 4.5 | | 4.4 | | 4.4 | | V |
| | | 4.5 | I _O =-8 mA | 3.94 | | | 3.8 | | 3.7 | | |
| V _{OL} | Low Level Output Voltage | 4.5 | I _O =50 μA | | 0.0 | 0.1 | | 0.1 | | 0.1 | V |
| | | 4.5 | I _O =8 mA | | | 0.36 | | 0.44 | | 0.55 | |
| I _I | Input Leakage Current | 0 to 5.5 | V _I = 5.5V or GND | | | ± 0.1 | | ± 1.0 | | ± 1.0 | μA |
| I _{CC} | Quiescent Supply Current | 5.5 | V _I = V _{CC} or GND | | | 1 | | 10 | | 20 | μA |
| +I _{CC} | Additional Worst Case Supply Current | 5.5 | One Input at 3.4V, other input at V _{CC} or GND | | | 1.35 | | 1.5 | | 1.5 | mA |

AC ELECTRICAL CHARACTERISTICS (Input t_r = t_f = 3ns)

| Symbol | Parameter | Test Condition | | Value | | | | | | Unit | |
|------------------|------------------------|------------------------|------------------------|-----------------------|------|------|-------------|------|--------------|------|------|
| | | V _{CC} (V) | C _L (pF) | T _A = 25°C | | | -40 to 85°C | | -55 to 125°C | | |
| | | | | Min. | Typ. | Max. | Min. | Max. | Min. | | Max. |
| t _{PLH} | Propagation Delay Time | 5.0 (*) | 15 | | 4.6 | 7.0 | 1.0 | 8.0 | 1.0 | 9.0 | ns |
| t _{PHL} | | 5.0 (*) | 50 | | 5.1 | 7.5 | 1.0 | 8.5 | 1.0 | 9.5 | |

(*) Voltage range is 5.0V ± 0.5V

CAPACITIVE CHARACTERISTICS

| Symbol | Parameter | Test Condition | | Value | | | | | | Unit | |
|-----------------|--|----------------|--|-----------------------|------|------|-------------|------|--------------|------|------|
| | | | | T _A = 25°C | | | -40 to 85°C | | -55 to 125°C | | |
| | | | | Min. | Typ. | Max. | Min. | Max. | Min. | | Max. |
| C _{IN} | Input Capacitance | | | | 4 | 10 | | 10 | | 10 | pF |
| C _{PD} | Power Dissipation Capacitance (note 1) | | | | 14 | | | | | | pF |

1) C_{PD} is defined as the value of the IC's internal equivalent capacitance which is calculated from the operating current consumption without load. (Refer to Test Circuit). Average operating current can be obtained by the following equation. I_{CC(oper)} = C_{PD} × V_{CC} × f_{IN} + I_{CC}

TEST CIRCUIT



$C_L = 15/50\text{pF}$ or equivalent (includes jig and probe capacitance)
 $R_T = Z_{OUT}$ of pulse generator (typically 50Ω)

WAVEFORM: PROPAGATION DELAY ($f=1\text{MHz}$; 50% duty cycle)

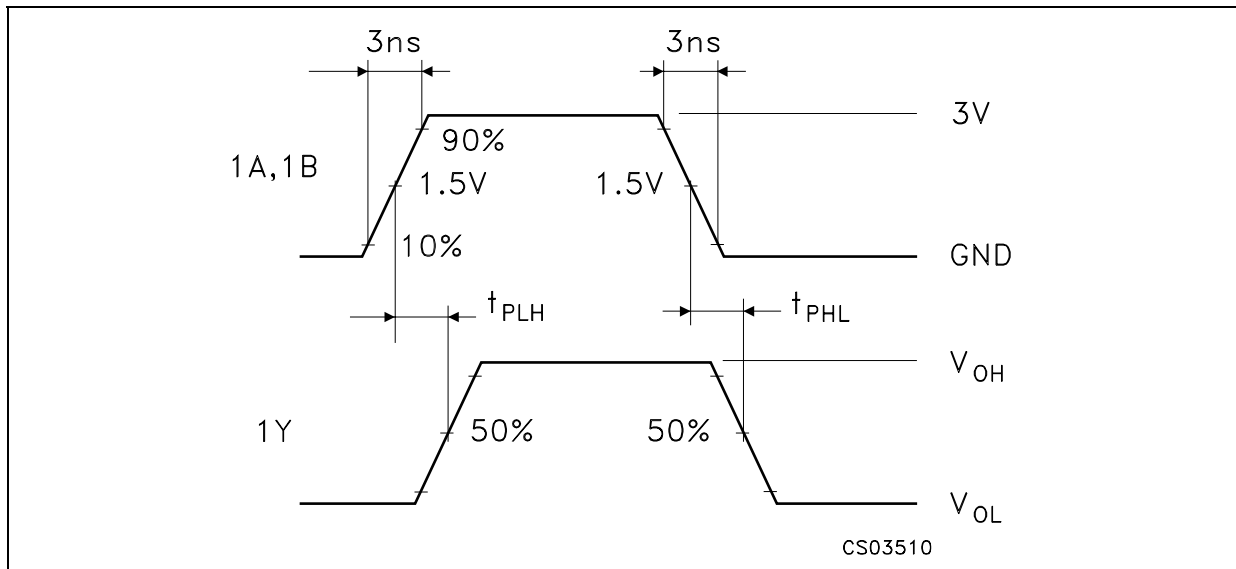

| |
|---------------------------------|
| SOT23-5L MECHANICAL DATA |
|---------------------------------|

| DIM. | mm. | | | mils | | |
|------|------|------|------|-------|------|-------|
| | MIN. | TYP. | MAX. | MIN. | TYP. | MAX. |
| A | 0.90 | | 1.45 | 35.4 | | 57.1 |
| A1 | 0.00 | | 0.10 | 0.0 | | 3.9 |
| A2 | 0.90 | | 1.30 | 35.4 | | 51.2 |
| b | 0.35 | | 0.50 | 13.7 | | 19.7 |
| C | 0.09 | | 0.20 | 3.5 | | 7.8 |
| D | 2.80 | | 3.00 | 110.2 | | 118.1 |
| E | 1.50 | | 1.75 | 59.0 | | 68.8 |
| e | | 0.95 | | | 37.4 | |
| H | 2.60 | | 3.00 | 102.3 | | 118.1 |
| L | 0.10 | | 0.60 | 3.9 | | 23.6 |



SOT323-5L MECHANICAL DATA

| DIM. | mm. | | | mils | | |
|------|------|------|------|------|------|------|
| | MIN. | TYP | MAX. | MIN. | TYP. | MAX. |
| A | 0.80 | | 1.10 | 31.5 | | 43.3 |
| A1 | 0.00 | | 0.10 | 0.0 | | 3.9 |
| A2 | 0.80 | | 1.00 | 31.5 | | 39.4 |
| b | 0.15 | | 0.30 | 5.9 | | 11.8 |
| C | 0.10 | | 0.18 | 3.9 | | 7.1 |
| D | 1.80 | | 2.20 | 70.9 | | 86.6 |
| E | 1.80 | | 2.40 | 70.9 | | 94.5 |
| E1 | 1.15 | | 1.35 | 45.3 | | 53.1 |
| e | | 0.65 | | | 25.6 | |
| e1 | | 1.3 | | | 51.2 | |
| L | 0.10 | | 0.30 | 3.9 | | 11.8 |

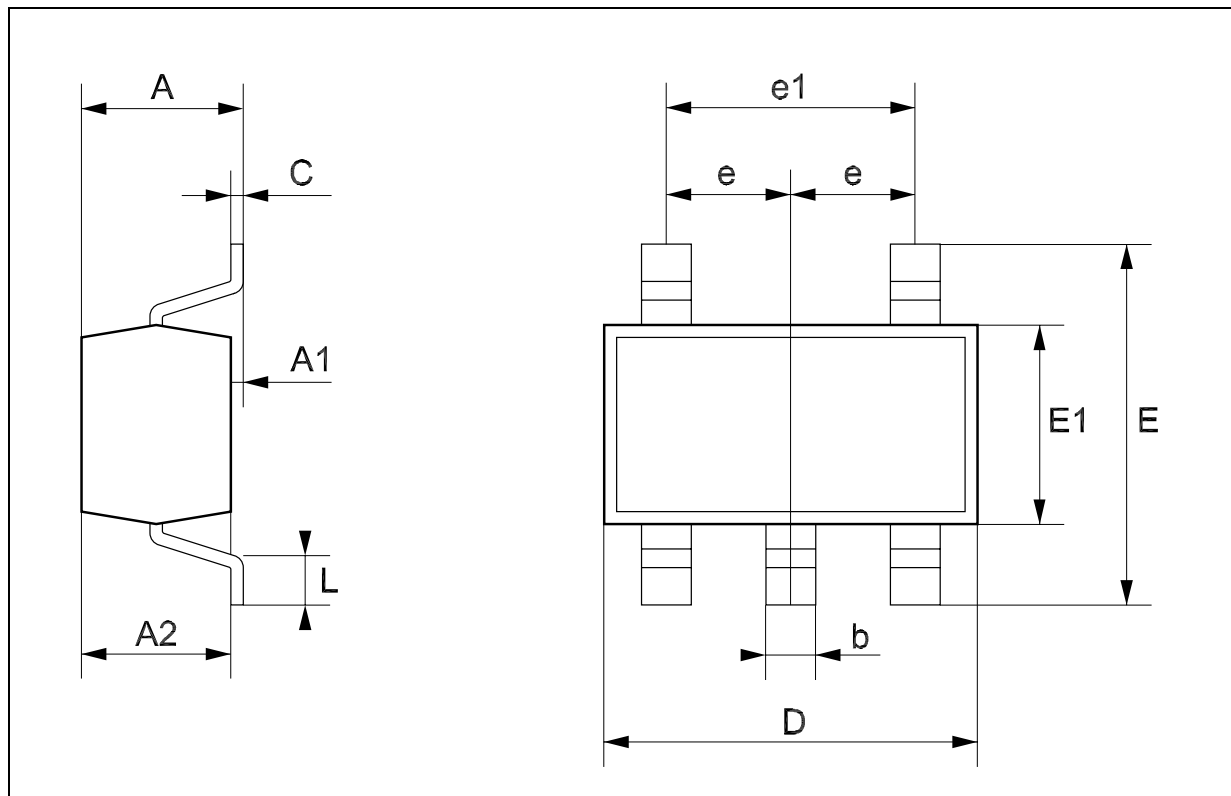

Tape & Reel SOT23-xL MECHANICAL DATA

| DIM. | mm. | | | inch | | |
|------|------|------|------|-------|-------|-------|
| | MIN. | TYP | MAX. | MIN. | TYP. | MAX. |
| A | | | 180 | | | 7.086 |
| C | 12.8 | 13.0 | 13.2 | 0.504 | 0.512 | 0.519 |
| D | 20.2 | | | 0.795 | | |
| N | 60 | | | 2.362 | | |
| T | | | 14.4 | | | 0.567 |
| Ao | 3.13 | 3.23 | 3.33 | 0.123 | 0.127 | 0.131 |
| Bo | 3.07 | 3.17 | 3.27 | 0.120 | 0.124 | 0.128 |
| Ko | 1.27 | 1.37 | 1.47 | 0.050 | 0.054 | 0.058 |
| Po | 3.9 | 4.0 | 4.1 | 0.153 | 0.157 | 0.161 |
| P | 3.9 | 4.0 | 4.1 | 0.153 | 0.157 | 0.161 |

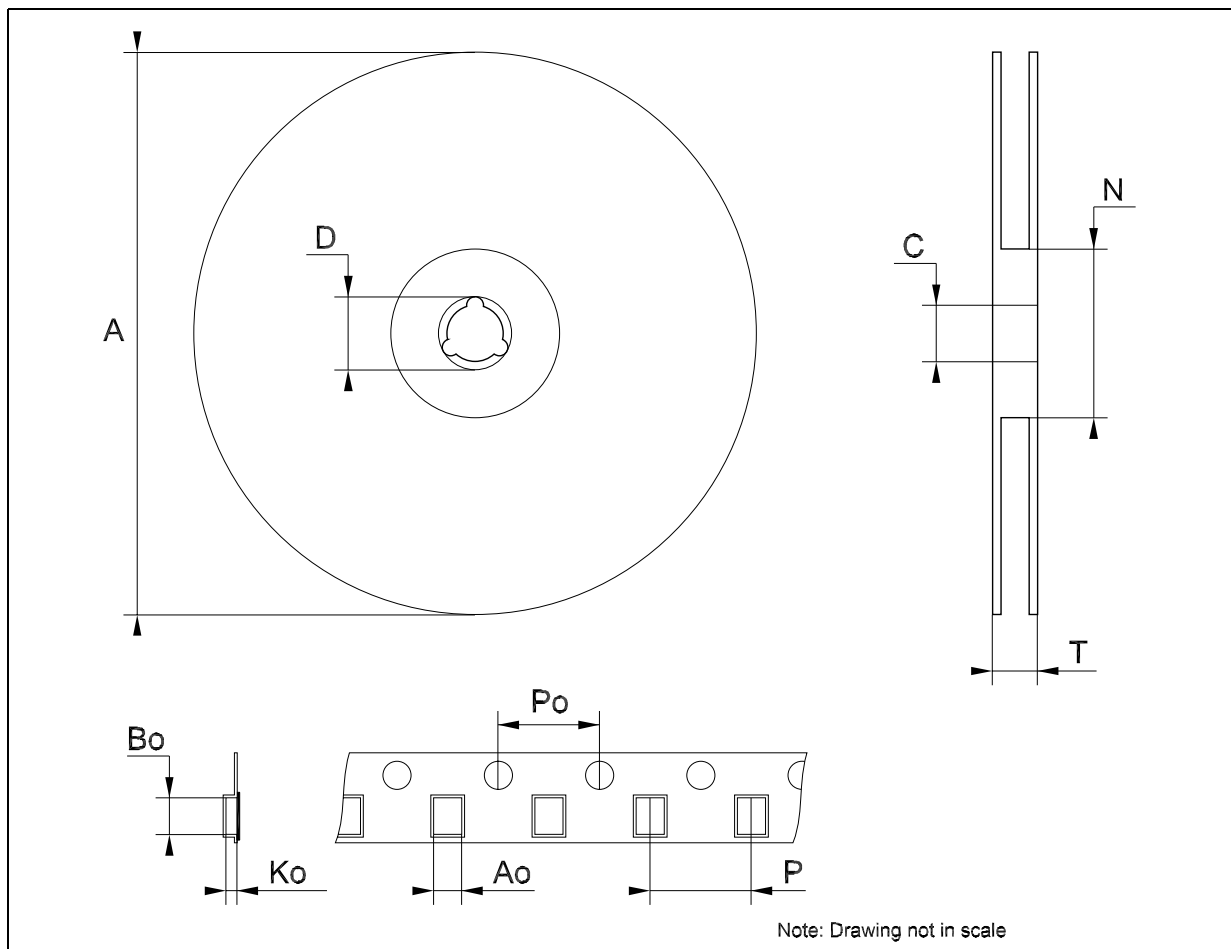

Tape & Reel SOT323-xL MECHANICAL DATA

| DIM. | mm. | | | inch | | |
|------|------|------|------|-------|-------|-------|
| | MIN. | TYP | MAX. | MIN. | TYP. | MAX. |
| A | 175 | 180 | 185 | 6.889 | 7.086 | 7.283 |
| C | 12.8 | 13 | 13.2 | 0.504 | 0.512 | 0.519 |
| D | 20.2 | | | 0.795 | | |
| N | 59.5 | 60 | 60.5 | | 2.362 | |
| T | | | 14.4 | | | 0.567 |
| Ao | | 2.25 | | | 0.088 | |
| Bo | | 2.7 | | | 0.106 | |
| Ko | | 1.2 | | | 0.047 | |
| Po | 3.9 | 4 | 4.1 | 0.153 | 0.157 | 0.161 |
| P | 3.8 | 4 | 4.2 | 0.149 | 0.157 | 0.165 |

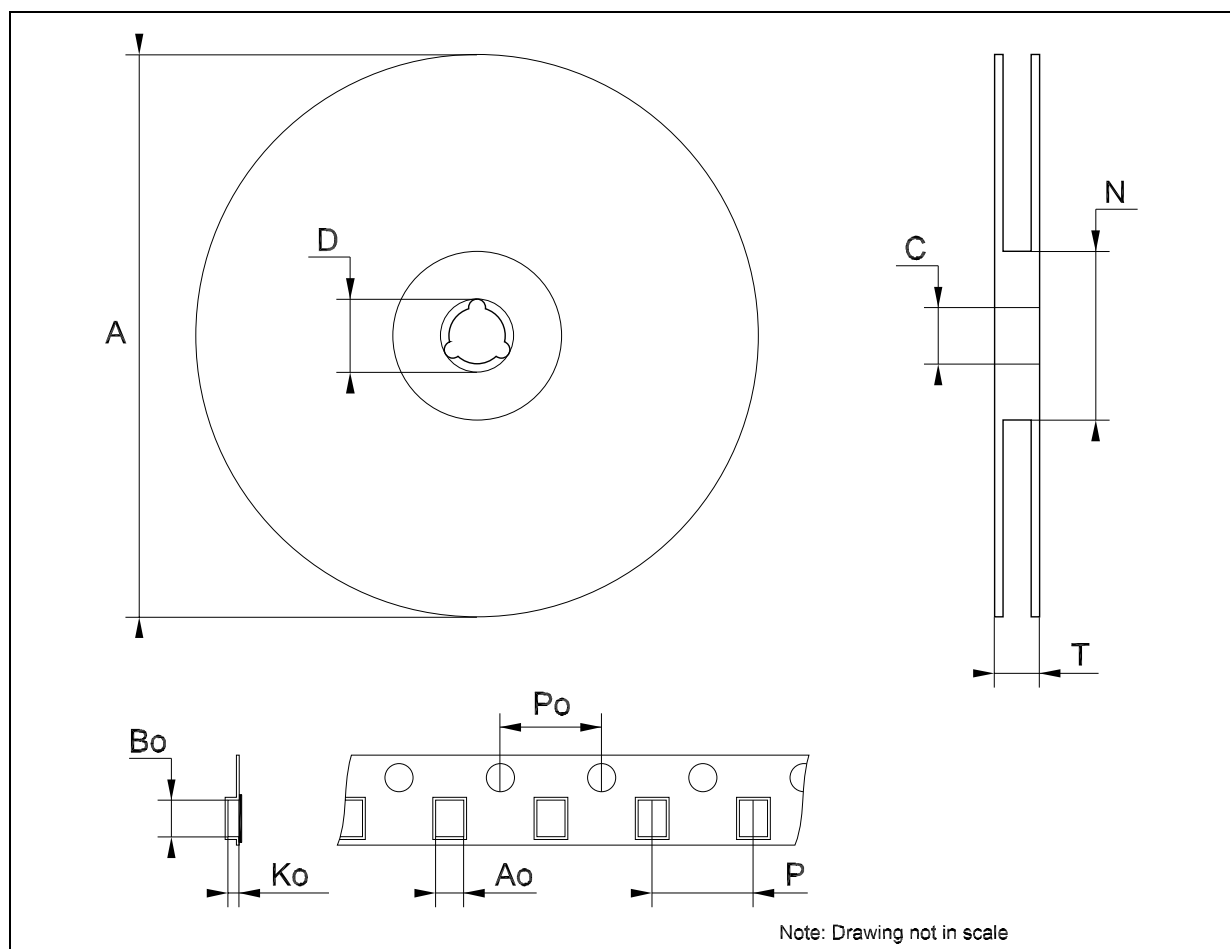

Information furnished is believed to be accurate and reliable. However, STMicroelectronics assumes no responsibility for the consequences of use of such information nor for any infringement of patents or other rights of third parties which may result from its use. No license is granted by implication or otherwise under any patent or patent rights of STMicroelectronics. Specifications mentioned in this publication are subject to change without notice. This publication supersedes and replaces all information previously supplied. STMicroelectronics products are not authorized for use as critical components in life support devices or systems without express written approval of STMicroelectronics.

The ST logo is a registered trademark of STMicroelectronics
All other names are the property of their respective owners

© 2004 STMicroelectronics - All Rights Reserved
STMicroelectronics GROUP OF COMPANIES

Australia - Belgium - Brazil - Canada - China - Czech Republic - Finland - France - Germany - Hong Kong - India - Israel - Italy - Japan -
Malaysia - Malta - Morocco - Singapore - Spain - Sweden - Switzerland - United Kingdom - United States.

<http://www.st.com>